

das

Wasser

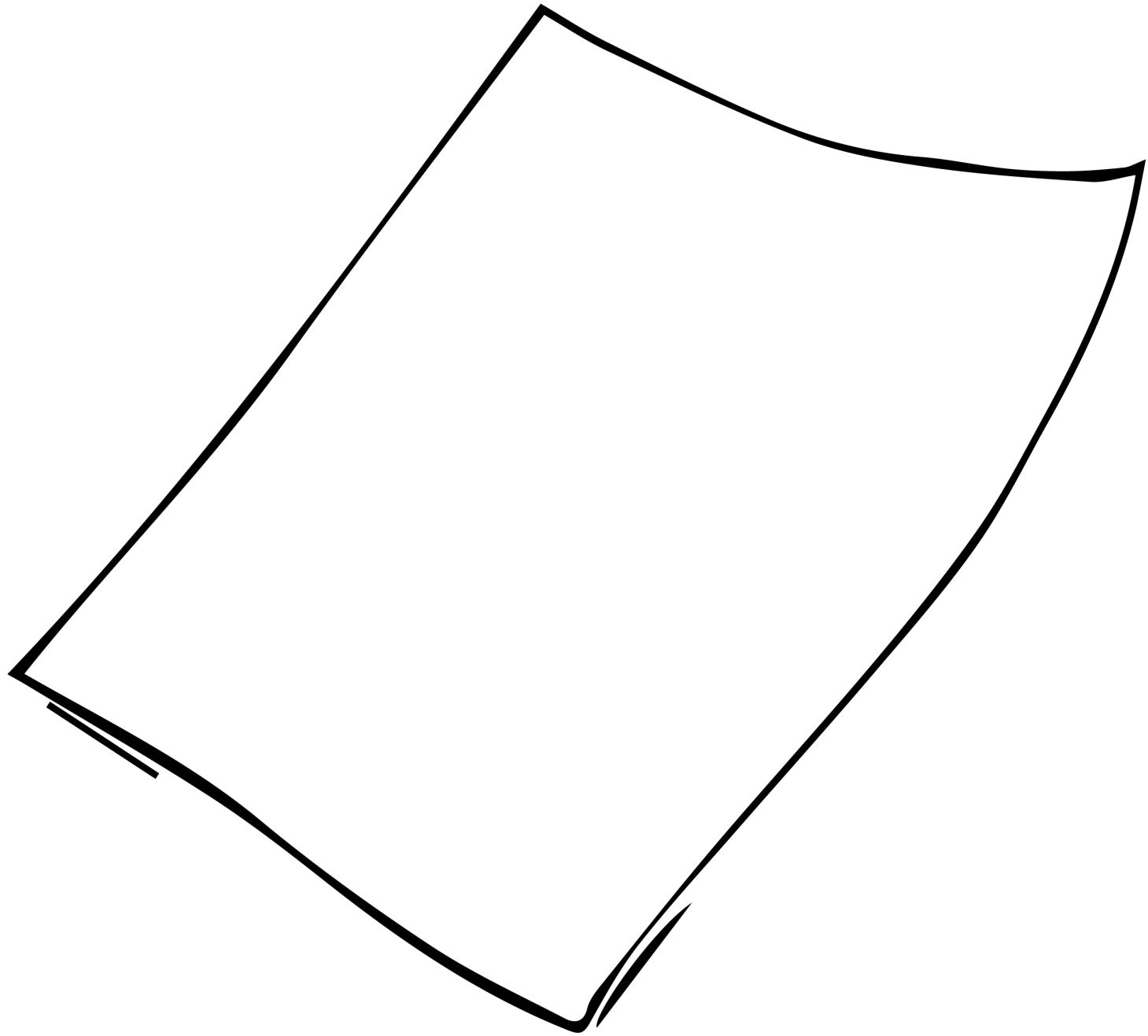

das

Papier

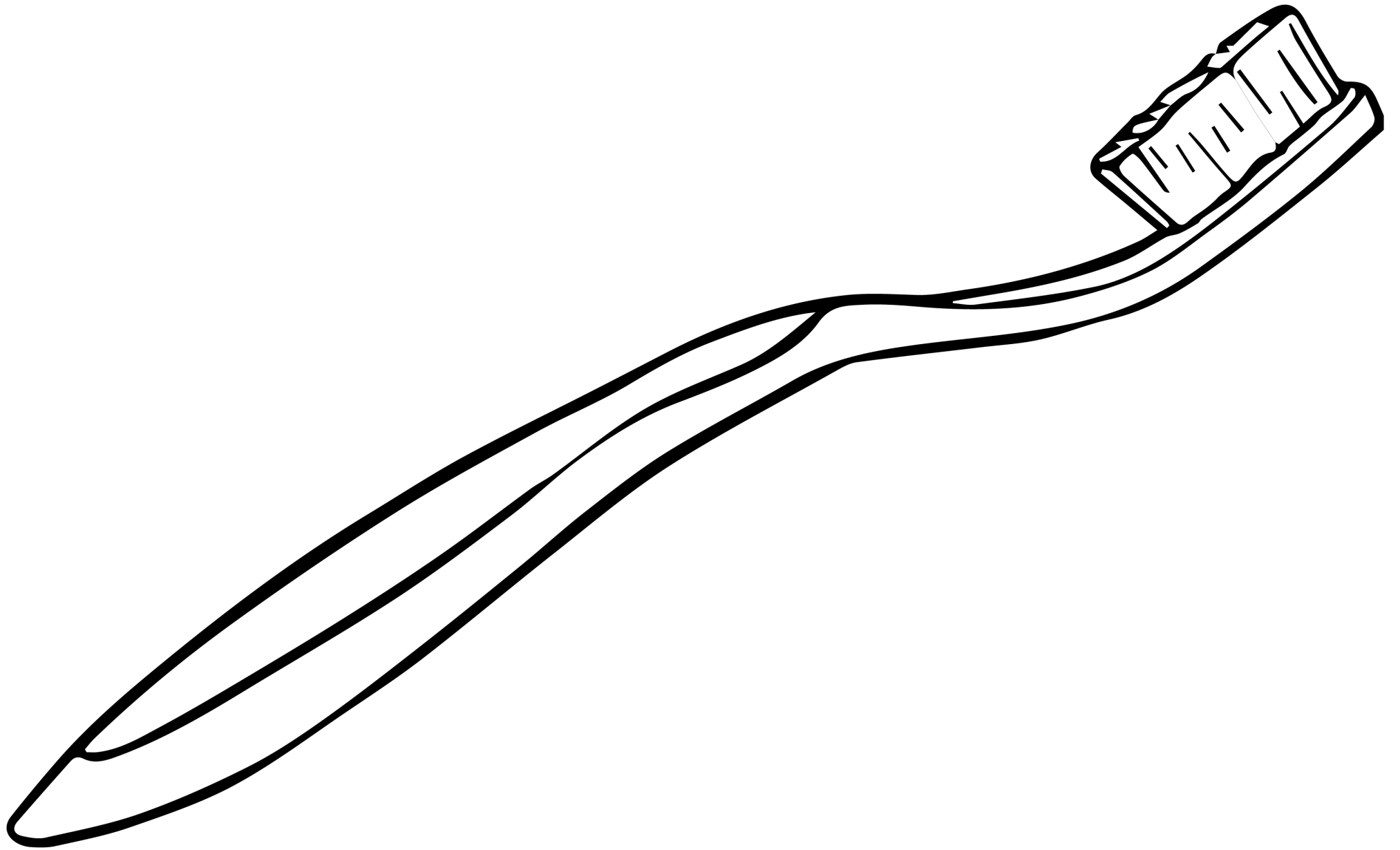

die

Zahnbürste



der

Tuschkasten



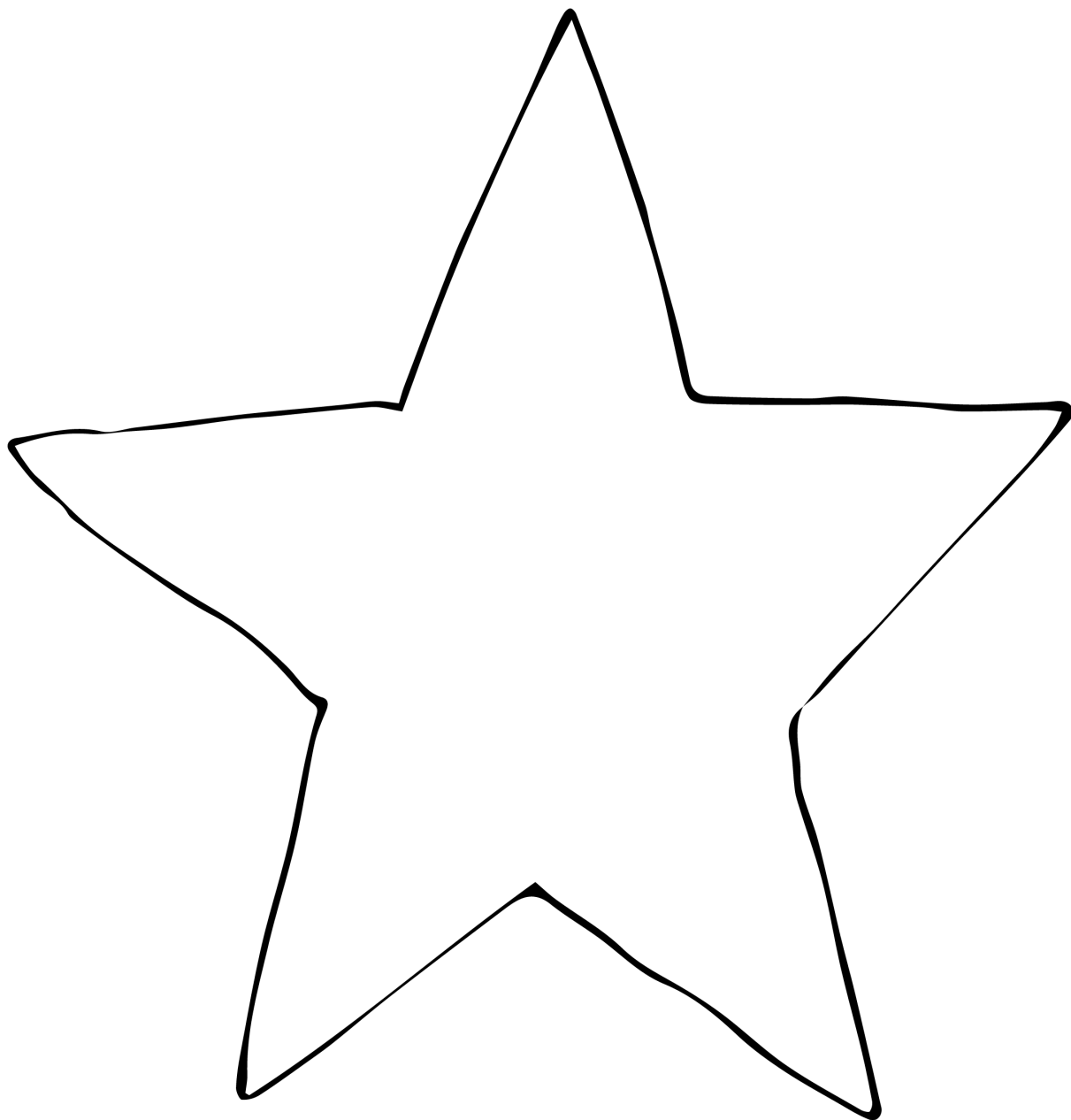

die

Schablone

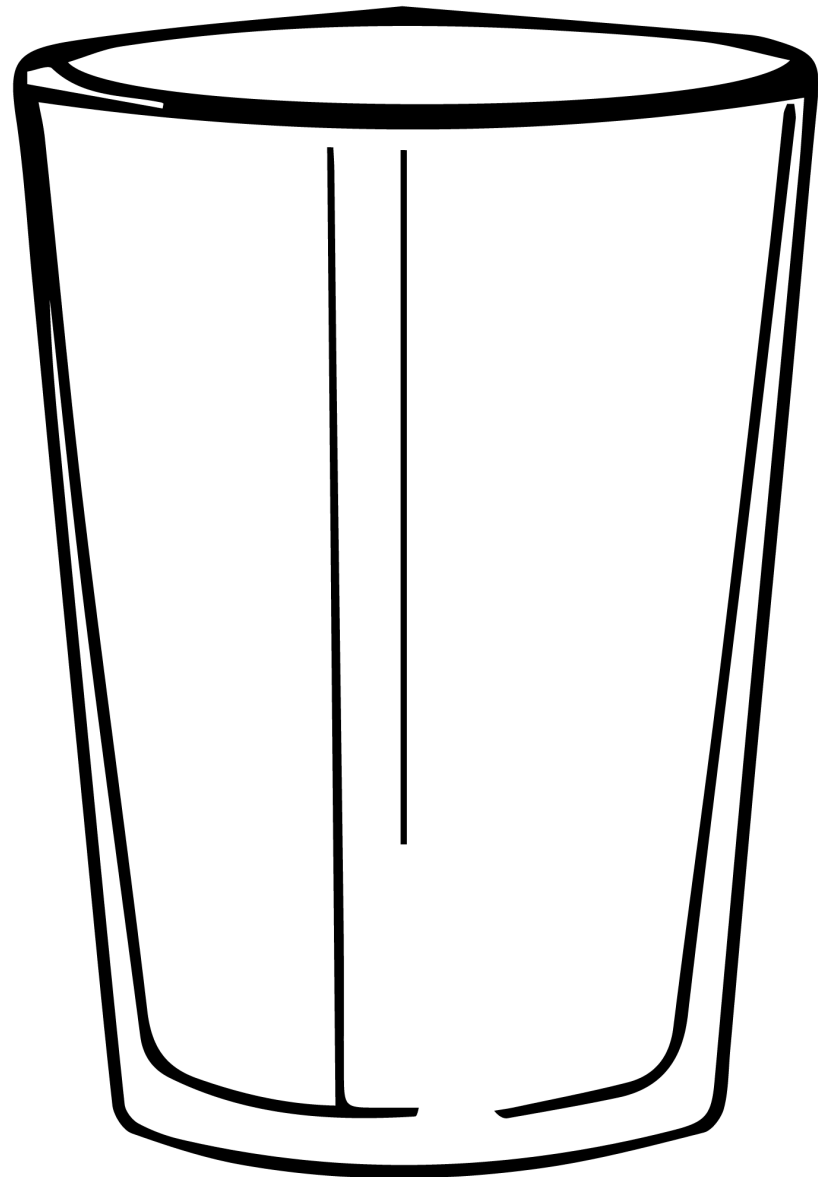

das

Glas

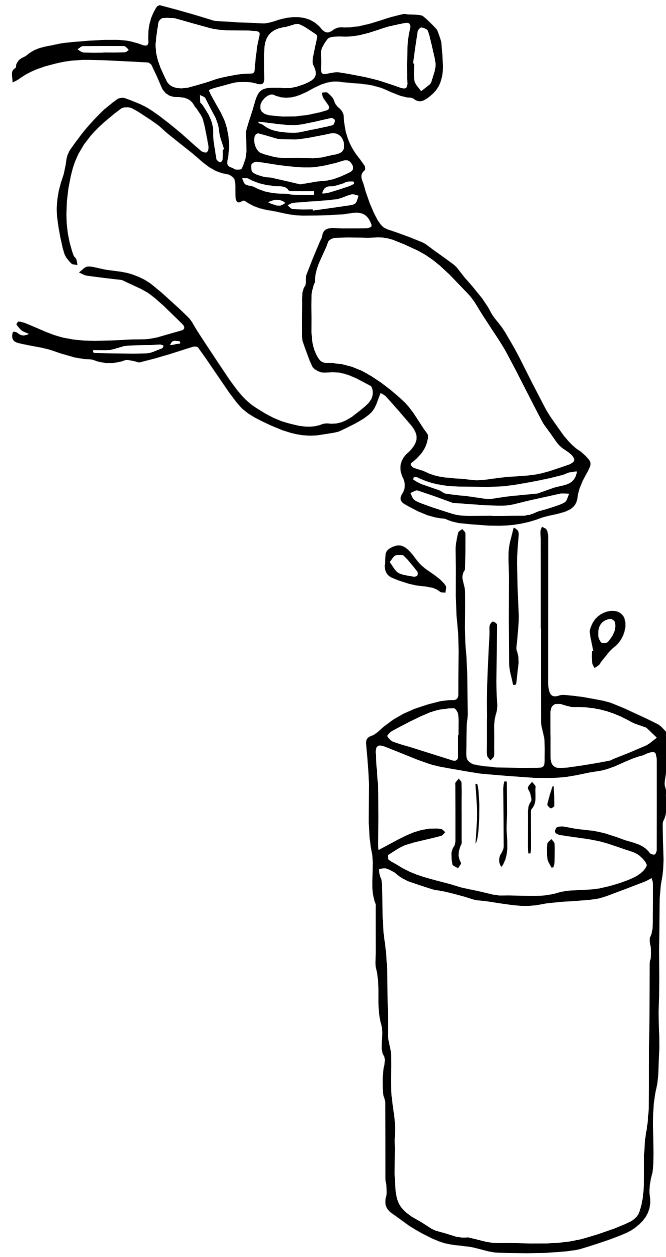

Wir haben Wasser  
in **ein** Glas gefüllt.

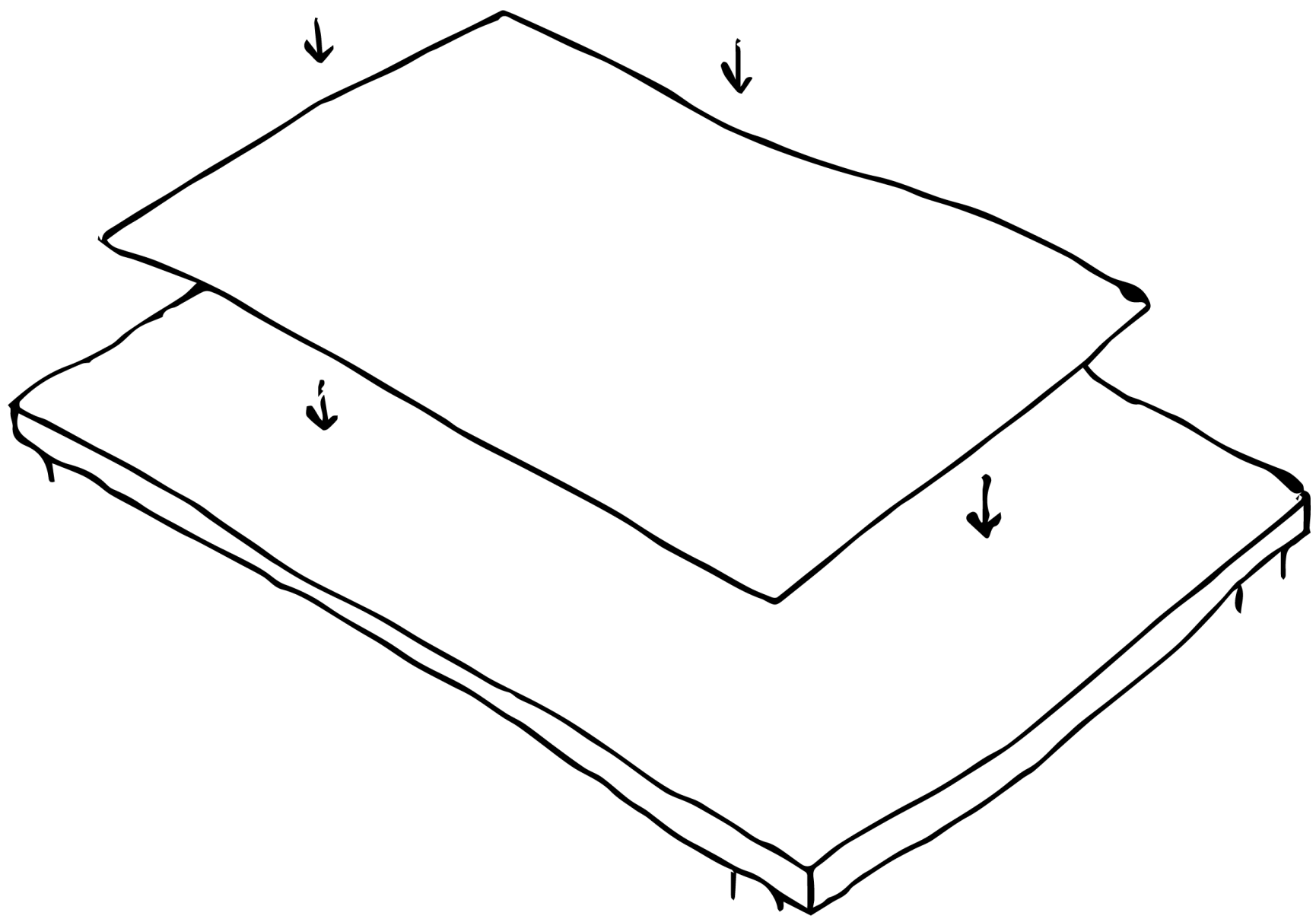

Wir haben das Papier  
auf den Tisch gelegt.



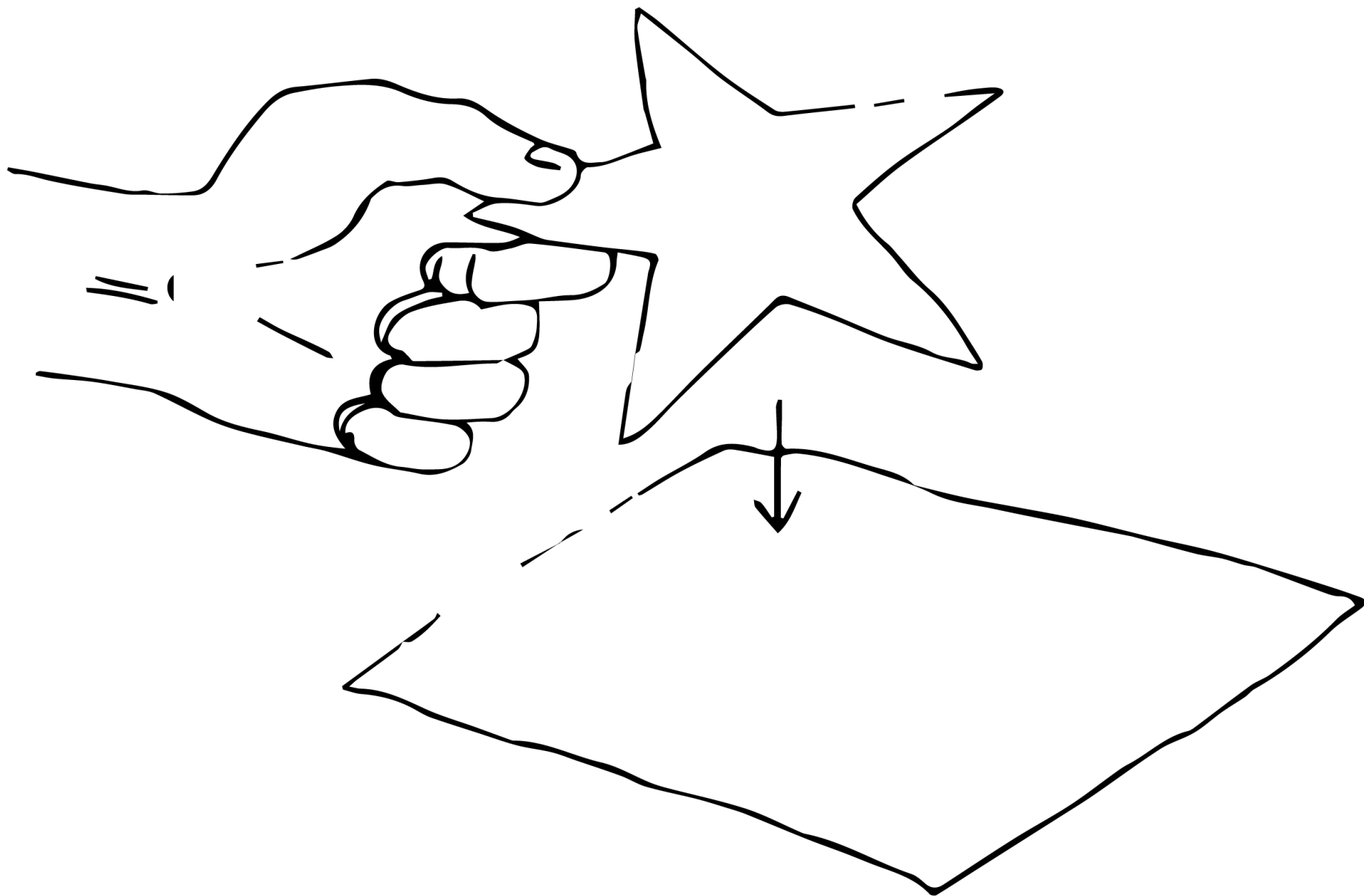

Wir haben

die Schablone

auf das Papier gelegt.

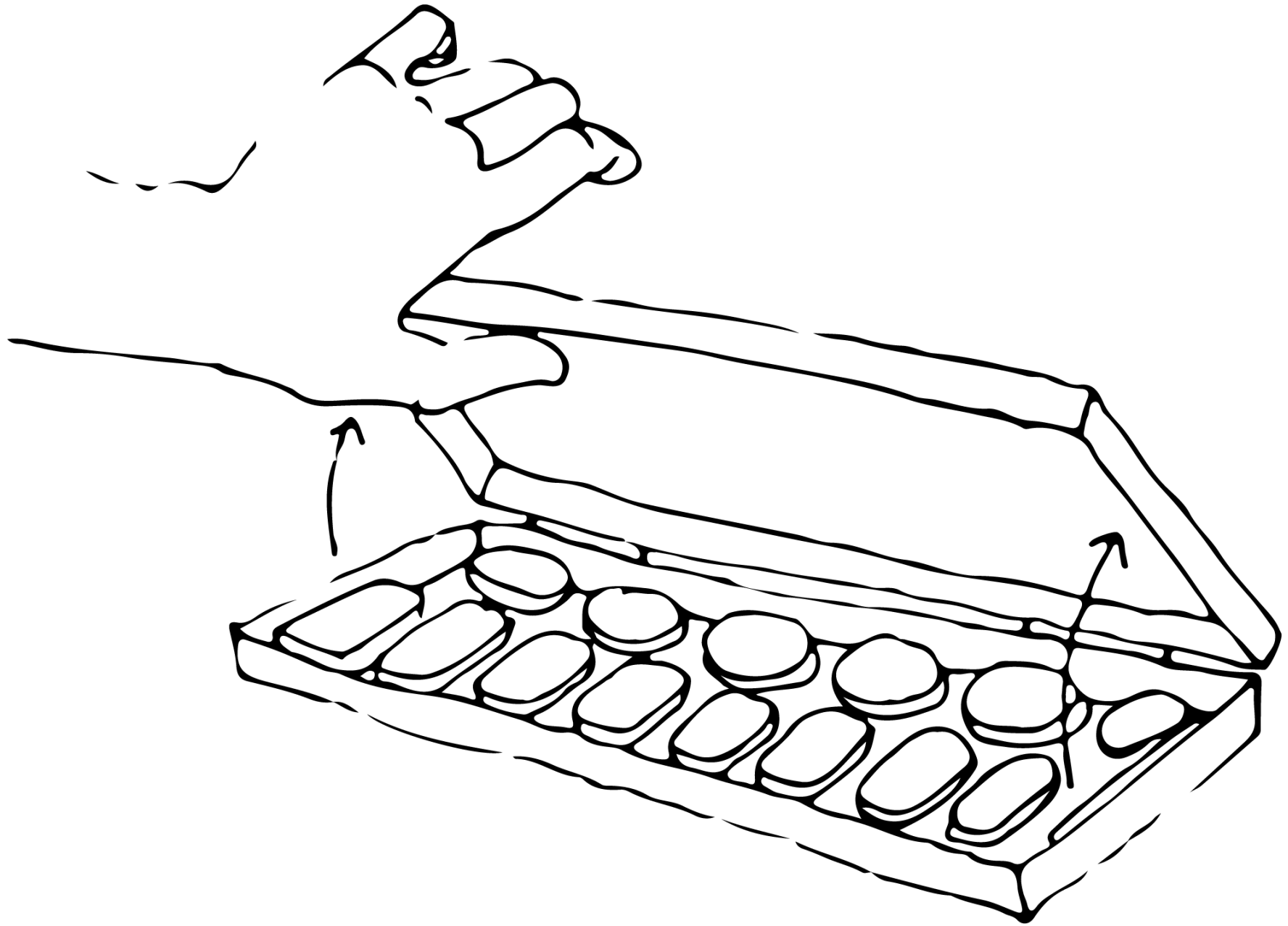

Wir haben den Deckel  
des Tuschkastens  
geöffnet.

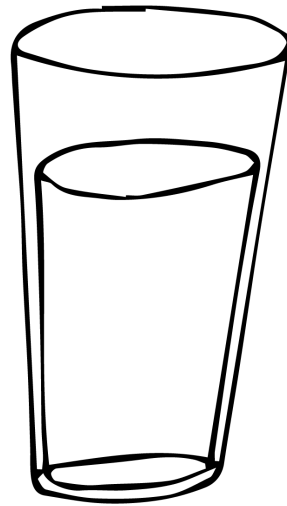

Wir haben

die Zahnbürste

in das Wasser getunkt.

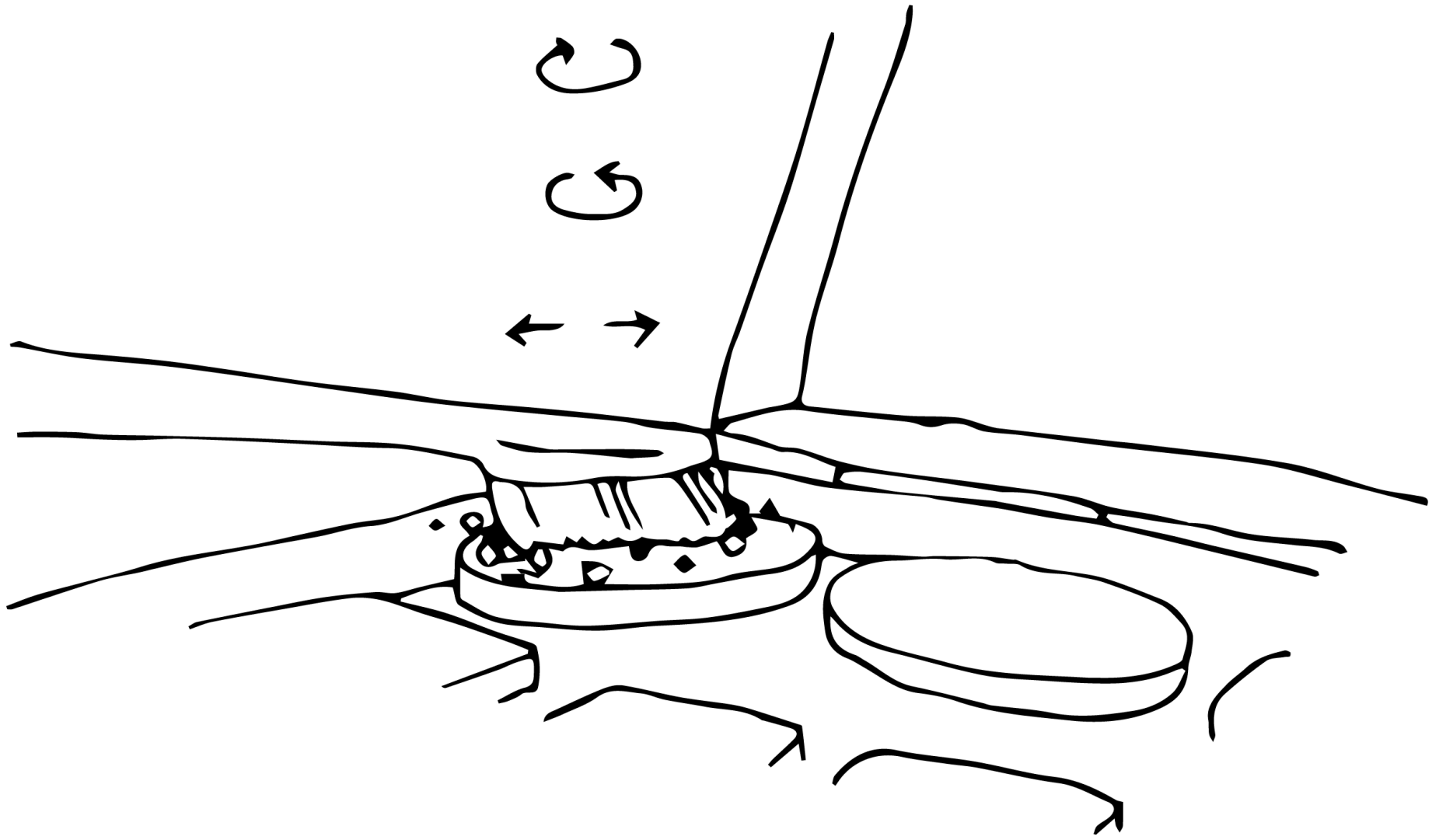

Wir haben mit  
der Zahnbürste  
in der Farbe gerieben.





Wir haben mit dem Daumen  
so über die Zahnbürste  
gestrichen, dass Farbe  
auf das Papier gespritzt ist.

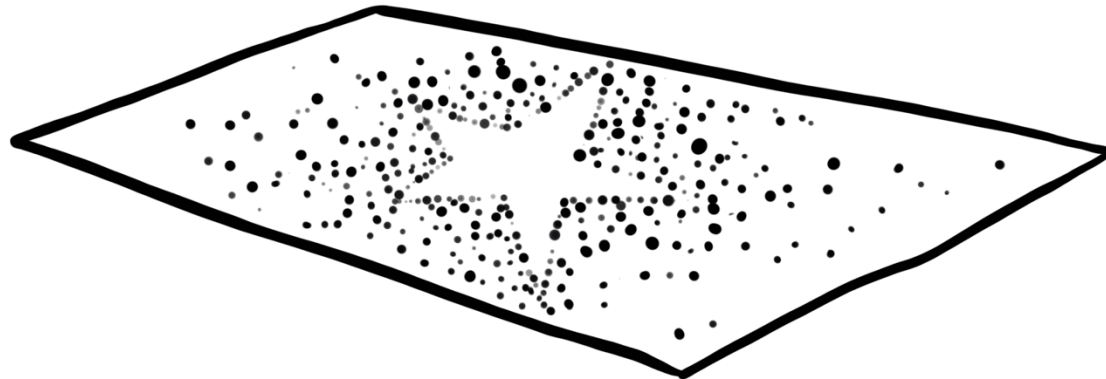
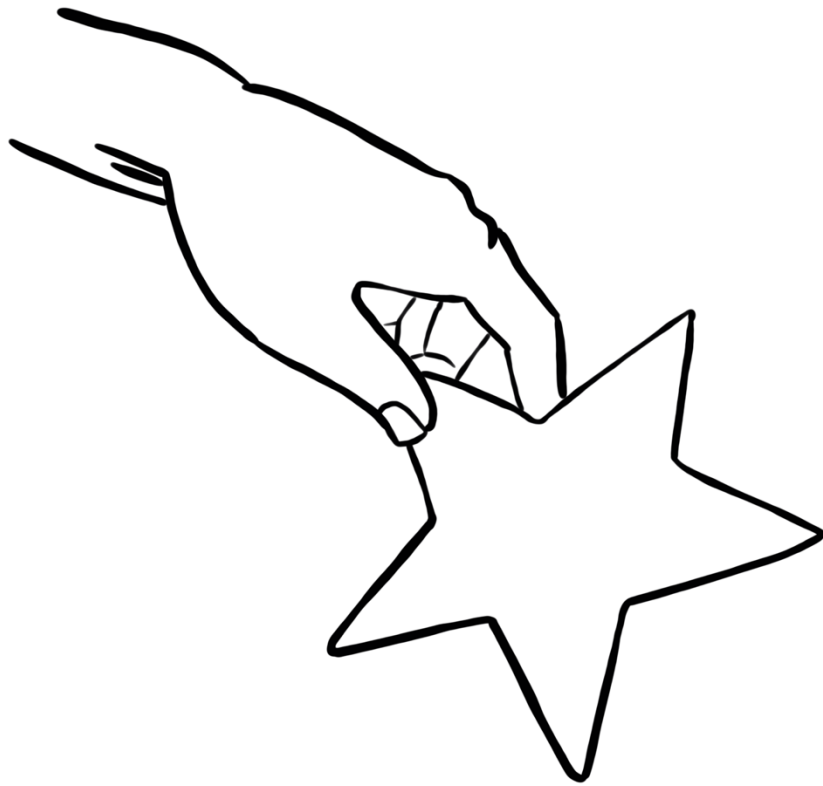

Wir haben  
die Schablone  
von unserem Papier  
entfernt.